



Surfboards

Custom Surfboard

Catalog

As always ... each board is

Hand Made

with **“Quality to the Core”**

in California, USA

Bruce Jones
High Performance Surfboards
Clean, Simple, Totally Functional,
Quality to the Core!

The spec sheets in the following pages are examples only.

As I make custom surfboards:

- ◇ I can adjust any of the measurements to fit your needs, and proportion any of the styles to fit your height, weight and experience.
- ◇ Tail shapes, rockers, deck contours, etc. may also be changed, as each board is hand shaped by me.
- ◇ Having extensive knowledge of blanks and rockers, I can alter any of these designs to fit your individual preferences.

Bruce Jones



Bruce Jones

Custom Surfboard Price List (US\$)

Hand made with **US Blanks** polyurethane foam with polyester resin construction, or hand made with **White Hot** EPS foam with epoxy resin, priced ready to surf, with fins included, non-colored and with a sanded finish.

Modern Longboards, Mini-longboards, Big Boy's Thrusters, Hybrids, Eggs, Fish, Retro Noseriders, Fatties etc

- ◇ Up to 6'-0" \$500
- ◇ Up to 6'-6" \$525
- ◇ Up to 7'-0" \$550
- ◇ Up to 7'-6" \$575
- ◇ Up to 8'-0" \$600
- ◇ Up to 8'-6" \$625
- ◇ Up to 9'-0" (3-1/8" max thickness) \$650
- ◇ Up to 9'-6" (3-1/4" max thickness) \$675
- ◇ Up to 10'-0" (3-1/2" max thickness) \$700
- ◇ Up to 10'-6" (3-5/8" max thickness) \$750
- ◇ Up to 11'-0" (4" max thickness) \$800
- ◇ Up to 12'-0" (4-1/2" max thickness) \$900 (max thickness does not apply to eps/epoxy construction)

Standard Features:

- ◇ All boards are designed and shaped by **Bruce Jones**.
- ◇ First quality **US Blanks** Polyurethane Foam or **White Hot** EPS foam with basswood center stringer.
- ◇ Clear (non-colored) glassing by **Waterman's Guild Fiberglassing** with a maximum of two layers on the bottom and three layers on the deck, in 4, 6 or 7.5 ounce **Hexcell** Silane fiberglass.
- ◇ **High quality** sanded finish.

Options:

- ◇ **Gloss and polish**, up to 8'-10" \$75, up to 9'-6" \$80, up to 10'-0" \$85, up to 10'-6" \$90, up to 11'-0" \$95, up to 12'-0" \$100
- ◇ **Color charges** by specific quote only (minimum - per color per side) \$30 **Pinlines**, each \$25
- ◇ **Nose or Tail blocks** single cut: \$50 double cut: \$75
- ◇ **Extra or oversized stringers** (each) \$30 and up depending on width and length
- ◇ **EPS/Epoxy construction**, up to 7'-0" \$85, up to 8'-0" \$90, up to 9'-0" \$100, up to 10'-0" \$110, up to 11'0" \$135, up to 12'-0" \$160
- ◇ **7.5 oz Volan** Fiberglass, per side \$40
- ◇ **Opaque or tint** lamination color, per side \$50 in **Volan** Fiberglass, per side \$60
- ◇ **Single Fin box** with custom Fiberglass Fin, or glassed on single fin **\$60**
- ◇ **Fish Charge** (larger blank must be used) \$25
- ◇ **Add two side fins** to a longboard shape (Future, O'fishl, FCS, glassed-on's) \$20
- ◇ **FCS, Future or glassed-on** Tri Fin System: \$35
- ◇ **FCS, Future or glassed-on** Quad Fin System: \$45

How to Order

Filling out The Surfboard Order Form

- ◇ **Name** - please print clearly as your name is inked on the board near the serial number.
- ◇ **Date** address etc. - just fill in.
- ◇ **Previous experience** - beginner, advanced or how many years of surfing.
- ◇ **Shaping** - the style of board, i.e., high performance thruster, hybrid, longboard, or any combination that makes sense.
- ◇ **Length** - the bottom measured length (waterline length) of the board, which is the convention. If you prefer a deck measured length, please indicate under shaping comments.
- ◇ **Width** - maximum width measured at the widest part of the outline, usually near center.
- ◇ **Thickness** - maximum thickness at the thickest part of the board, usually near center.
- ◇ **Nose and Tail** - the width of the outline measured 12" from each end.
- ◇ **Tail shape** - the actual outline shape of the tail, i.e., square, squash, rounded pin, swallow etc.
- ◇ **Deck contours** - the width-wise shape of the deck, i.e., flat, semi-flat, domed or semi-domed.
- ◇ **Bottom contours** - the width-wise shape of the bottom, i.e., flat to v, flat to concave v, concave nose to flat to v, etc.
- ◇ **Rails** - the profile of the rail as viewed in a cross section, i.e., thin and tapered, full and not tapered, or any description that makes sense - we can figure it out!
- ◇ **Blank** - the density of the US Blanks Foam blank, i.e., ultra-light, superlight, superblue, or supergreen. The order is from lightest and weakest, to heaviest and strongest. (Blue and Green are code names - the foam is white!).
- ◇ **Stringers** - the center and/or offset wood stringers going lengthwise down and through the blank. The default is 1/8" to 1/4" basswood, depending on the length of the board.
- ◇ **Typical use** - where the board is going to be surfed most, i.e., a gentle reef break, a more hollow beach break, or the North Shore for example.
- ◇ **Shaping Comments** - anything you would like to get across to Bruce to help him shape a board best suited for you!
- ◇ **Graphics** - describe the color design you have in mind in your own words, the draw it on the order form or on a separate sheet.
- ◇ **Lamination** - strong, average, light, or very light. Remember, stronger boards are heavier, our standard glass jobs are stronger than most!
- ◇ **Labels** - describe which labels and their color, and draw where you would like them placed on the board.
- ◇ **Fins/boxes** - describe what type of fin set up you would like, i.e., three glassed-on thrusters, a center fin box with two glassed-on side fins, a center box with two Future side boxes, or any set-up you would like.
- ◇ **Pinlines** - any black lines going around and highlighting your art work. Special instructions - mainly for the finish of the board, either a sanded finish, or glossed and polished (two more steps).
- ◇ **Date due** - indicate when you would like the board. The default minimum is three weeks for boards with no or simple art work, six weeks for custom epoxy.

Bruce Jones

6-2 FISH™

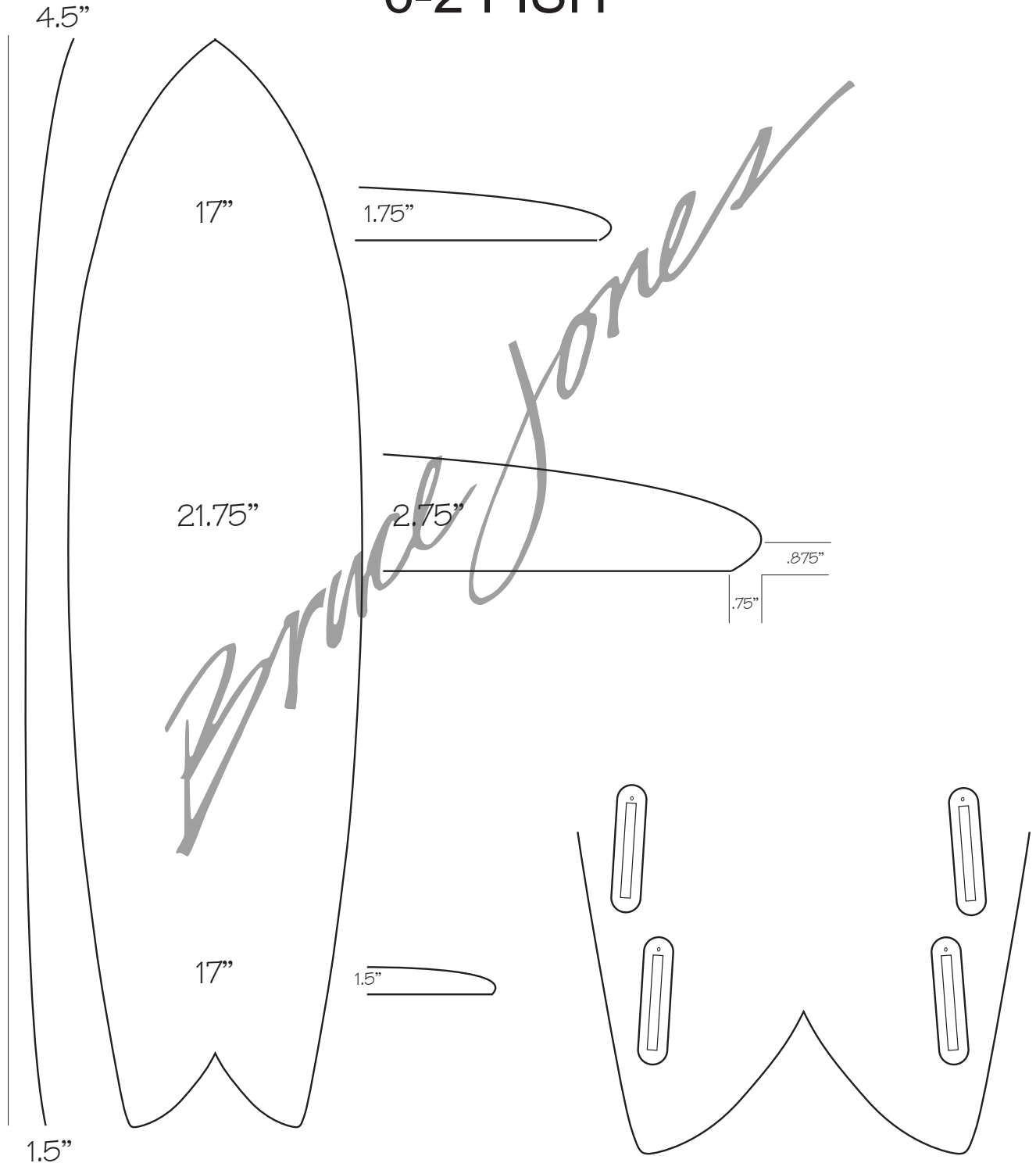

Bruce Jones

6-2 Big Boy's Thruster

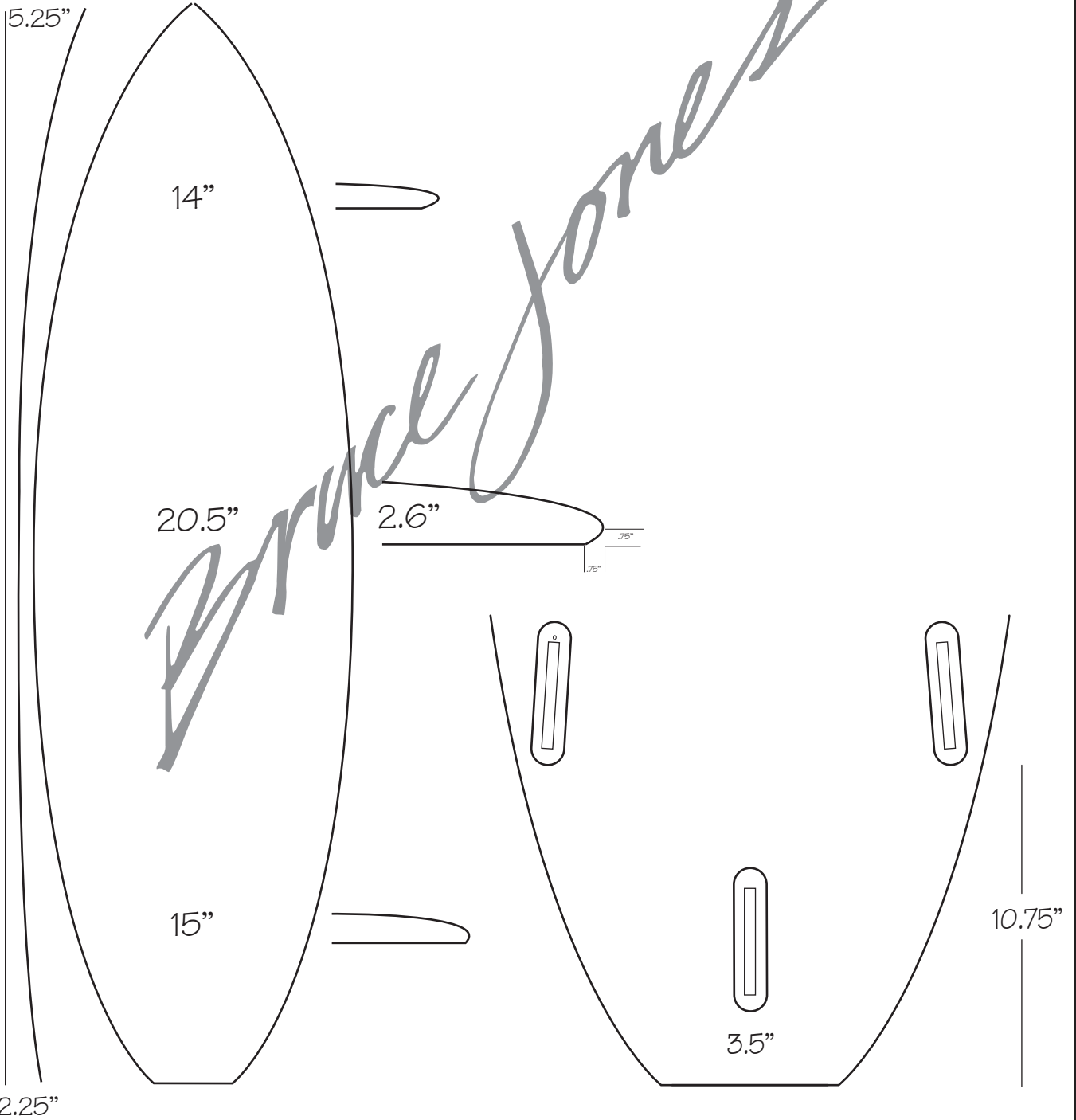

Bruce Jones

8-0 FATTY™

5.5"

16.5"

1.75"

23.75"

3.5"

.875"

.75"

16"

1.5"

2.5"

Bruce Jones

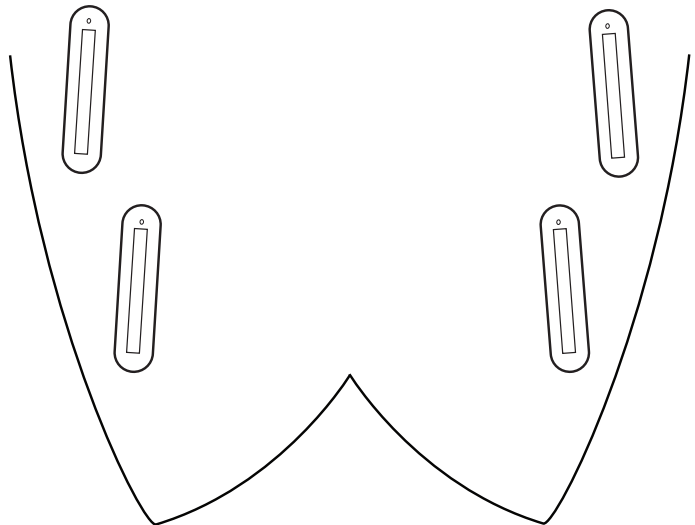

Bruce Jones

8-0 **EGG**TM

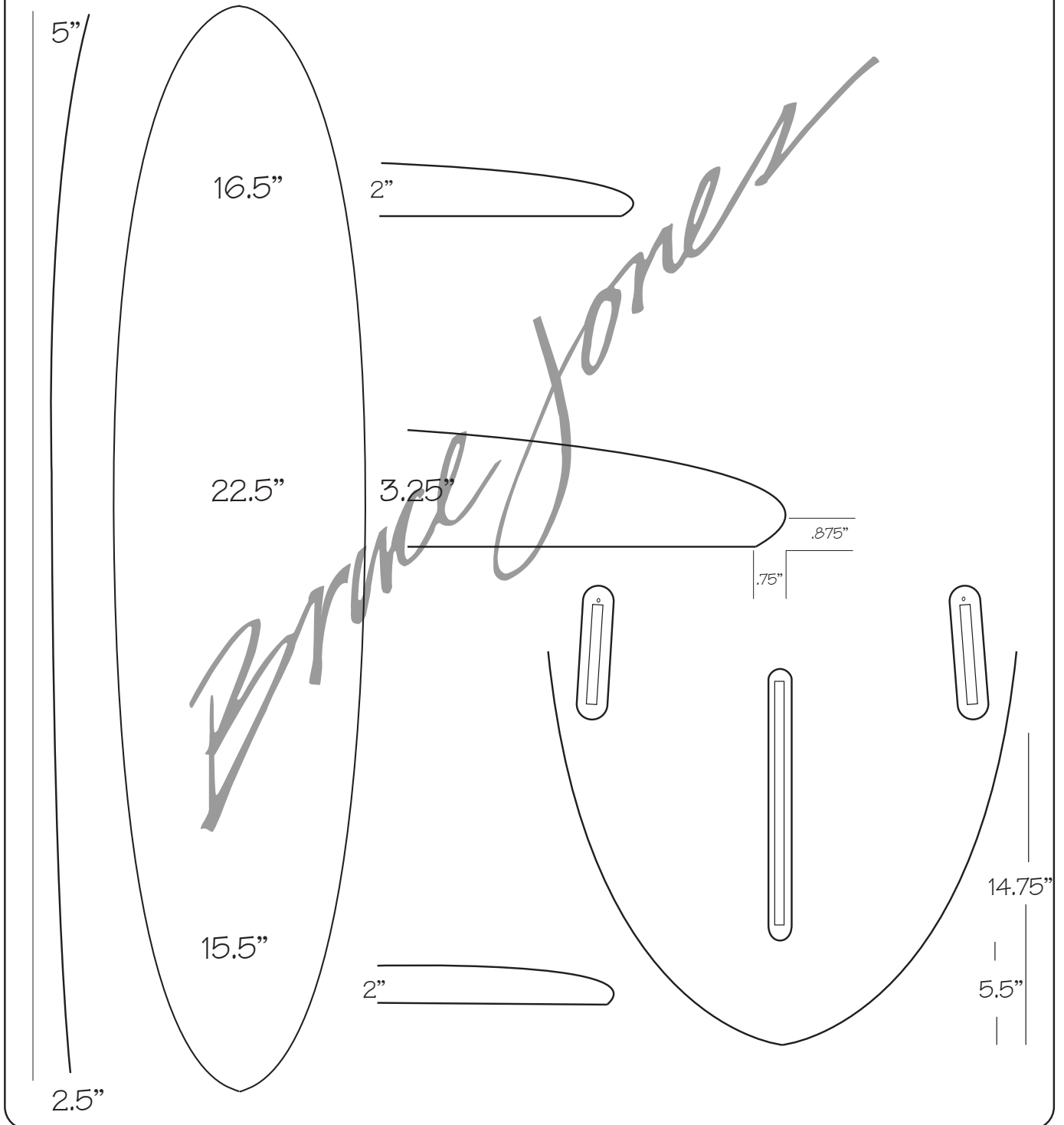

Bruce Jones

8-0 Hybrid™

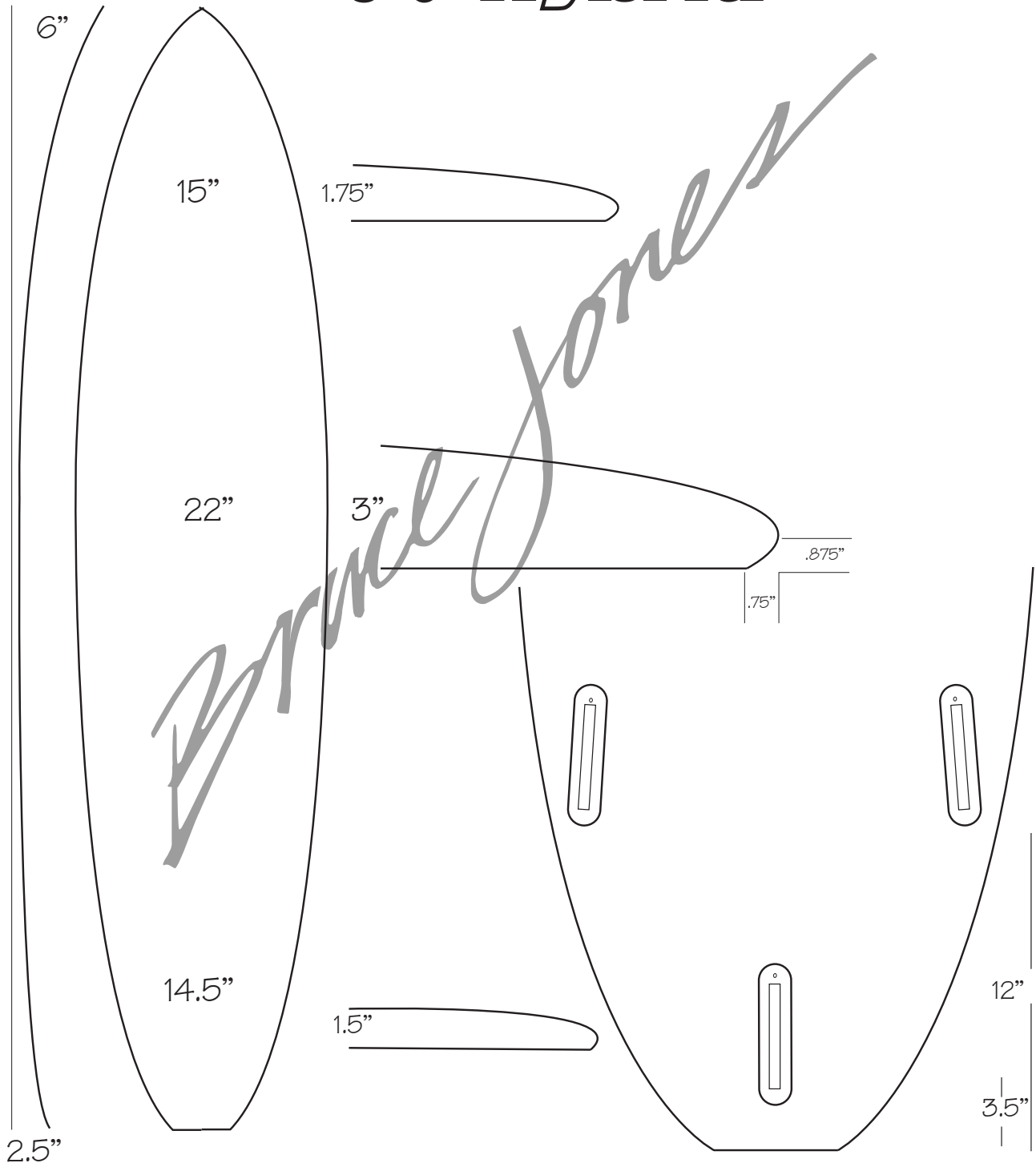

Bruce Jones

9-0 MODERN LONGBOARD™

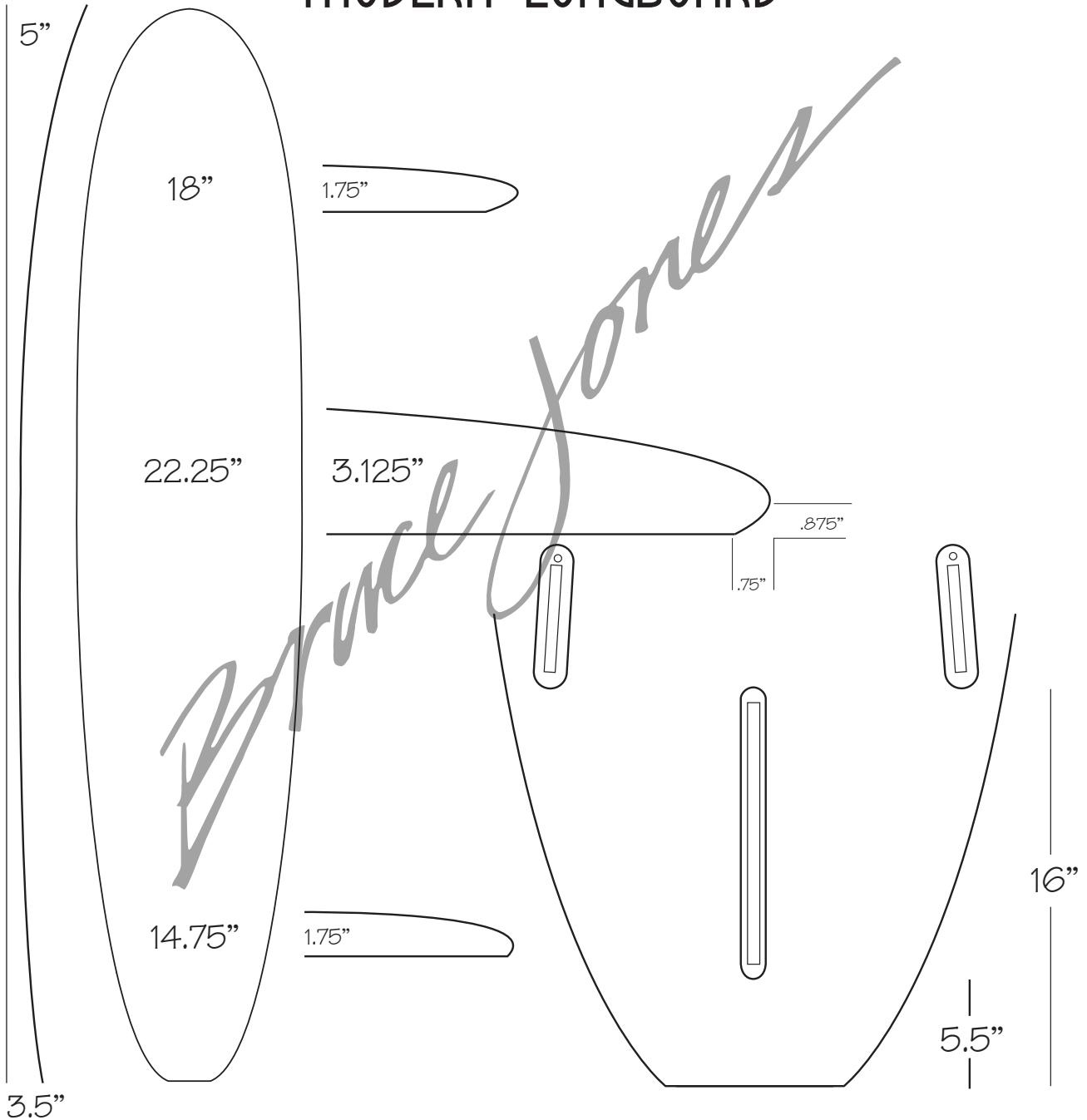

Bruce Jones

9-0

HI PERFORMANCE MODERN LONGBOARD™

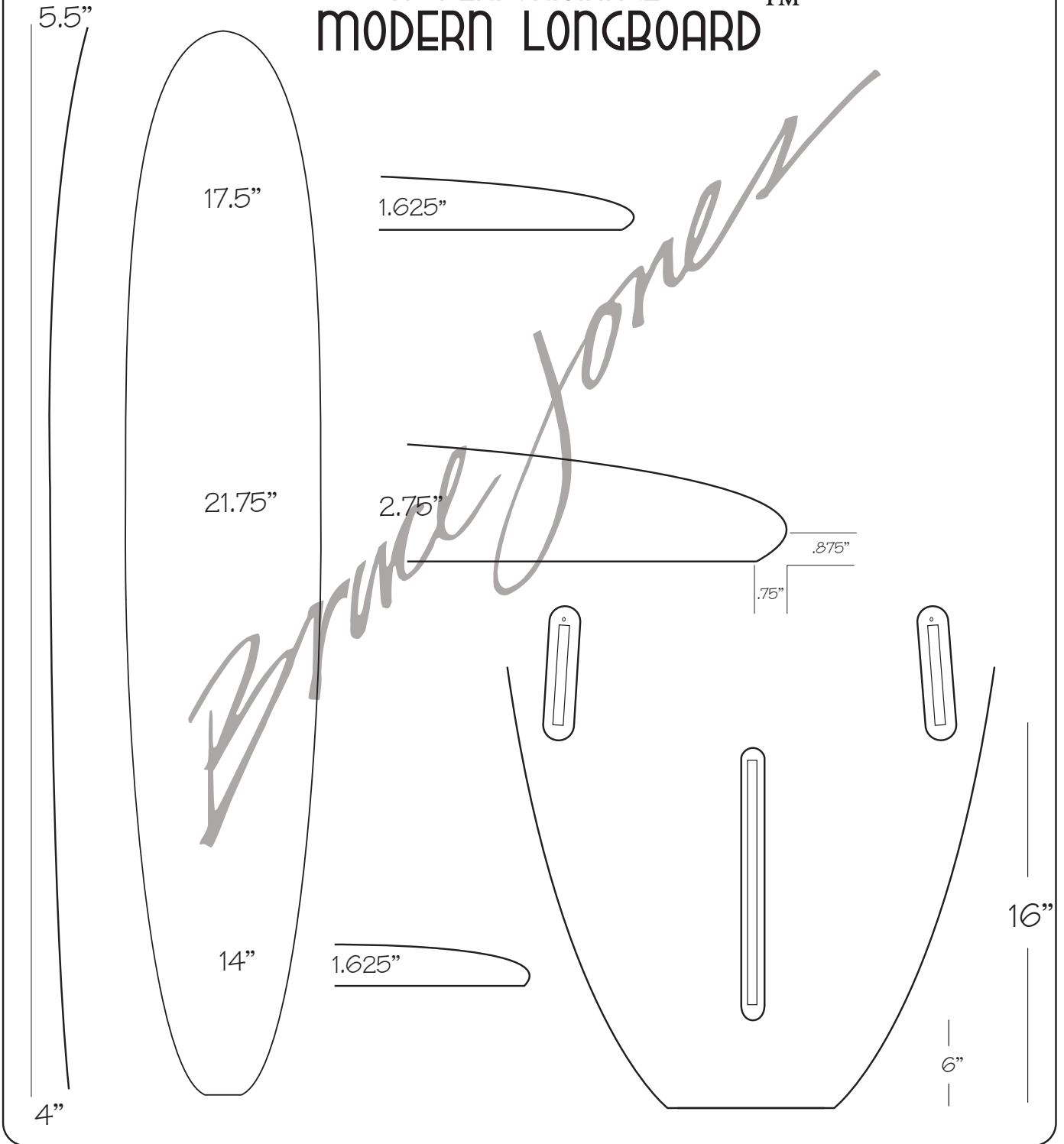

Bruce Jones

THE GLIDER™ 9-6

5"



4"

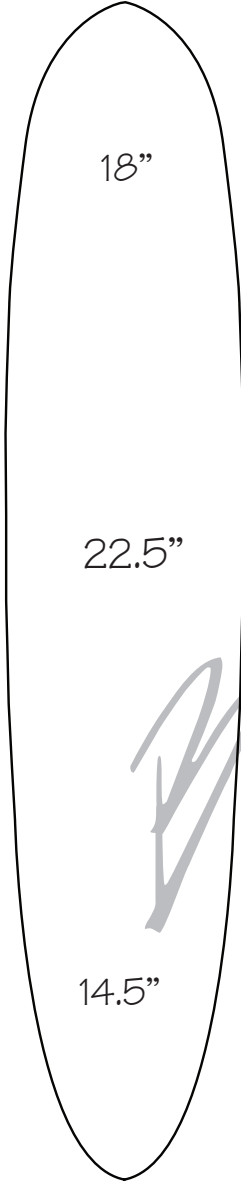

18"

22.5"

14.5"

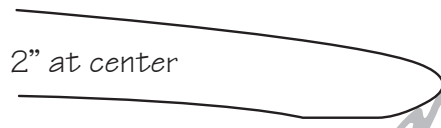

2" at center

concave nose

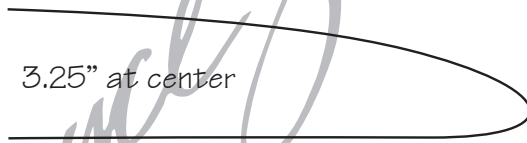

3.25" at center

.75"

2.5"

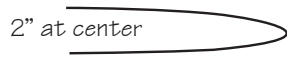

2" at center

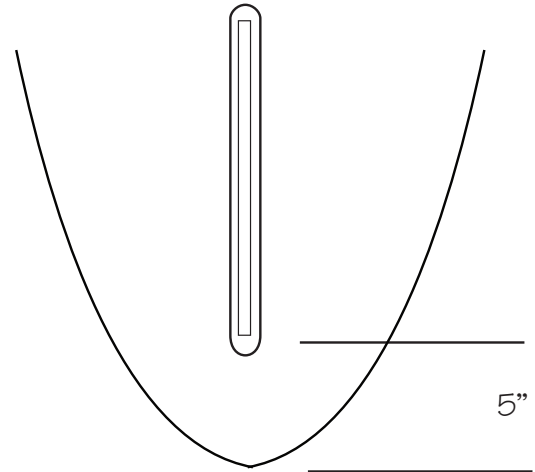

5"

Bruce Jones

9-6 retro noserider™

4.5"



4"

19"

23"

15.5"

2" at center

concave nose

3.25" at center

2.5"

.75"

2" at center

4.5"

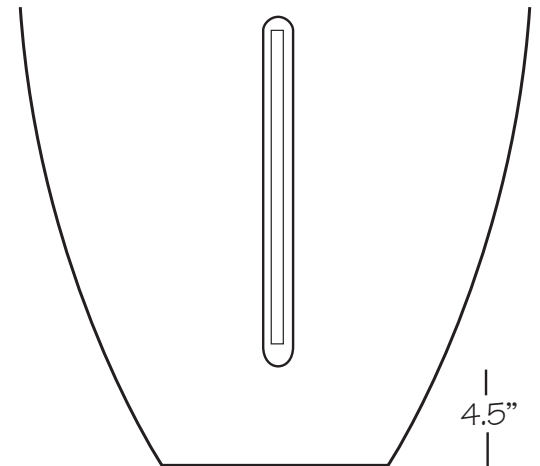



Bruce Jones Surfboards, Inc.
Sunset Beach CA 90742 888 592 2314
www.brucejones.com

Quality to the Core!